

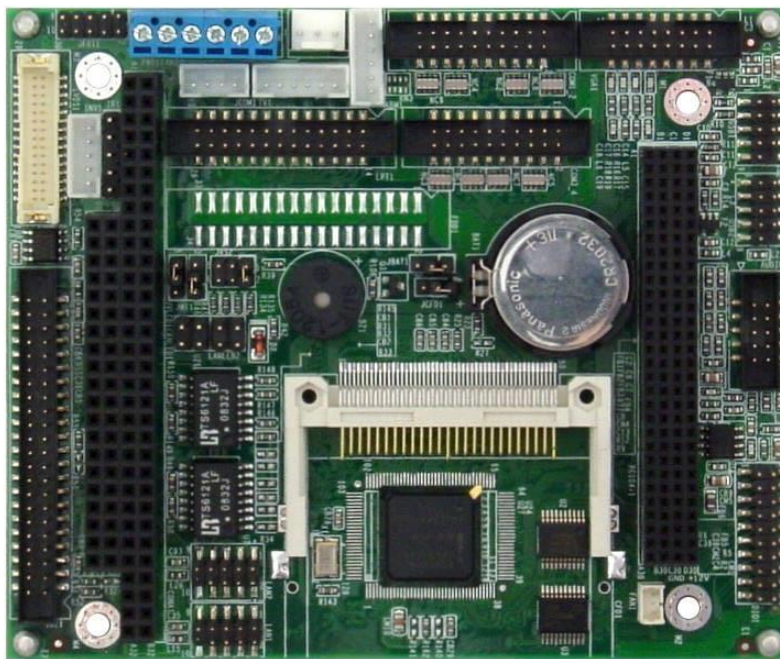

# PLUTO SINGLE BOARD COMPUTER

ETX Form-factor Embedded Platform with  
Configurable CPU and PC/104-Plus Expansion

User Manual



Revision	Date	Comment
A3	5/13/14	Updated with new AMD G-Series Pluto models
A4	4/30/15	Updated with new Pluto E3845 models
B	4/18/2022	Updated to new COM and carrier board models

**FOR TECHNICAL SUPPORT  
PLEASE CONTACT:**

[support@diamondsystems.com](mailto:support@diamondsystems.com)

© Copyright 2015-2022  
Diamond Systems Corporation  
[www.diamondsystems.com](http://www.diamondsystems.com)

# CONTENTS

<b>Important Safe-Handling Information .....</b>	<b>3</b>
<b>1. Introduction .....</b>	<b>5</b>
1.1 ETX Computer-on-Module (COM) Features .....	6
1.2 Pluto Baseboard Features.....	6
1.3 Thermal Considerations and Heatspreader .....	7
<b>2. Functional Overview.....</b>	<b>8</b>
2.1 Block Diagrams.....	8
2.2 Baseboard Dimensions .....	10
2.3 Baseboard Connectors and Jumpers.....	11
2.4 Interface Connector Summary.....	12
2.5 Configuration Jumper Summary.....	13
<b>3. Getting started .....</b>	<b>14</b>
3.1 Introducing the Pluto Development Kit .....	14
3.1.1 Pluto Cable Kit .....	15
3.2 System Setup .....	16
3.2.1 Display .....	16
3.2.2 Keyboard and Mouse.....	16
3.2.3 Mass Storage Devices.....	16
3.2.4 Connecting Power.....	16
3.2.5 Installing Pluto in an Enclosure.....	17
3.3 Booting the System .....	17
3.3.1 BIOS Setup.....	17
3.3.2 Operating System Drivers.....	17
<b>4. Interface Connector Details .....</b>	<b>18</b>
4.1 PC/104-Plus stacking location (CONA1, PC104+).....	18
4.1.1 PC/104-Plus ISA Bus (CONA1).....	18
4.1.2 PC/104-Plus PCI Bus (PC104+).....	20
4.2 USB1-USB4 (USB1, USB2) .....	21
4.3 Audio (AUDIO1).....	21
4.4 Digital I/O (DIO1).....	21
4.5 CPU Fan Power (FAN1).....	22
4.6 CompactFlash Socket (CFD1).....	22
4.7 Ethernet Status LEDs (LANLED1, LANLED2) .....	23
4.8 Ethernet LAN Interfaces (LAN1, LAN2).....	23
4.9 IDE (IDE1) .....	24
4.10 Infrared Interface (IR1) .....	25
4.11 LCD Inverter Interface (INV1).....	25
4.12 LCD LVDS Out (LVDS1) .....	26
4.13 Utility Signals (JFRT1).....	27
4.14 COM2 RS-422/485 Interface (JCOM1) .....	27
4.15 DC Power Input (PWR1) .....	28
4.16 TV Out (TV1) .....	29
4.17 Auxiliary Fan Power (FAN2).....	29
4.18 PS/2 Keyboard and Mouse (KBM1) .....	29
4.19 Parallel/Floppy (LPT1).....	30
4.20 COM1-COM4 RS-232 (COMA, COMB) .....	31
4.21 VGA Video Out (VGA1).....	31
4.22 SATA (SATA1, SATA2).....	32
4.23 LPC (LPC1) .....	32
<b>5. Configuration Jumper Details .....</b>	<b>33</b>
5.1 CMOS Setup Clear (JBAT1).....	33
5.2 COM2 RS-232/422/485 Mode (JRS2).....	33
5.3 CompactFlash IDE Mode (JCFD1).....	34
5.4 LCD Panel Voltage Select (JVLCD1) .....	34
5.5 LCD Backlight Select (JBLON1).....	34
5.6 Watchdog Timer Mode (JWT1) .....	35

## IMPORTANT SAFE-HANDLING INFORMATION



### **WARNING: ESD-Sensitive Electronic Equipment!**

**Observe ESD-safe handling procedures when working with this product.**

**Always use this product in a properly grounded work area and wear appropriate ESD-preventive clothing and/or accessories.**

**Always store this product in ESD-protective packaging when not in use.**

### **Safe Handling Precautions**

Pluto contains numerous I/O connectors that connect to sensitive electronic components. This creates many opportunities for accidental damage during handling, installation and connection to other equipment. The list here describes common causes of failure found on boards returned to Diamond Systems for repair. This information is provided as a source of advice to help you prevent damaging your Diamond (or any vendor's) embedded computer boards.

**ESD damage** – This type of damage is almost impossible to detect, because there is no visual sign of failure or damage. The symptom is that the board simply stops working, because some component becomes defective. Usually the failure can be identified and the chip can be replaced.

To prevent ESD damage, always follow proper ESD-prevention practices when handling computer boards.

**Damage during handling or storage** – On some boards we have noticed physical damage from mishandling. A common observation is that a screwdriver slipped while installing the board, causing a gouge in the PCB surface and cutting signal traces or damaging components.

Another common observation is damaged board corners, indicating the board was dropped. This may or may not cause damage to the circuitry, depending on what is near the corner. Most of our boards are designed with at least 25 mils clearance between the board edge and any component pad, and ground / power planes are at least 20 mils from the edge to avoid possible shorting from this type of damage. However these design rules are not sufficient to prevent damage in all situations.

A third cause of failure is when a metal screwdriver tip slips, or a screw drops onto the board while it is powered on, causing a short between a power pin and a signal pin on a component. This can cause overvoltage / power supply problems described below. To avoid this type of failure, only perform assembly operations when the system is powered off.

Sometimes boards are stored in racks with slots that grip the edge of the board. This is a common practice for board manufacturers. However our boards are generally very dense, and if the board has components very close to the board edge, they can be damaged or even knocked off the board when the board tilts back in the rack. Diamond recommends that all our boards be stored only in individual ESD-safe packaging. If multiple boards are stored together, they should be contained in bins with dividers between boards. Do not pile boards on top of each other or cram too many boards into a small location. This can cause damage to connector pins or fragile components.

**Power supply wired backwards** – Our power supplies and boards are not designed to withstand a reverse power supply connection. This will destroy each IC that is connected to the power supply. In this case the board will most likely will be unrepairable and must be replaced. A chip destroyed by reverse power or by excessive power will often have a visible hole on the top or show some deformation on the top surface due to vaporization inside the package. **Check twice before applying power!**

**Board not installed properly in PC/104 stack** – A common error is to install a PC/104 board accidentally shifted by 1 row or 1 column. If the board is installed incorrectly, it is possible for power and ground signals on the bus to make contact with the wrong pins on the board, which can damage the board. For example, this can damage components attached to the data bus, because it puts the  $\pm 12V$  power supply lines directly on data bus lines.

**Bent connector pins** – This type of problem is often only a cosmetic issue and is easily fixed by bending the pins back to their proper shape one at a time with needle-nose pliers. The most common cause of bent connector pins is when a PC/104 board is pulled off the stack by rocking it back and forth left to right, from one end of the connector to the other. As the board is rocked back and forth it pulls out suddenly, and the pins at the end get bent significantly. The same situation can occur when pulling a ribbon cable off of a pin header. If the pins are bent too severely, bending them back can cause them to weaken unacceptably or even break, and the connector must be replaced.

# 1. INTRODUCTION

Pluto is a high performance, highly integrated board-level embedded computer matching the footprint of the popular ETX computer-on-module (COM) standard.

Pluto’s CPU core consists of an ETX CPU module mounted on its bottom side, an approach that improves thermal management and increases the space for I/O functions and connectors. This innovative design has enabled Pluto to integrate additional serial and Ethernet controllers, a complete set of peripheral interface header connectors, and a PC/104-Plus expansion stack location – all within the compact ETX footprint.

Thanks to Pluto’s flexible architecture, product lifecycle can be extended, or performance can be improved, by replacing the existing CPU COM with a newer one. What’s more, Pluto’s on-board PC/104-Plus connectors enable the addition of custom or off-the-shelf ISA- and PCI-interfaced expansion modules, helping you satisfy your application’s precise I/O requirements.

Pluto is currently offered with a “Bay Trail” E3845 CPU COM and a range of memory capacities.

**IMPORTANT NOTE:** This manual applies only to the latest generation of Pluto consisting of the models listed below. These models are comprised of a new ETX module and a new carrier board that offer similar performance to previous versions but have some parts replaced due to obsolescence of the original parts. A separate user manual is available for previous models of Pluto. Please check the website or contact tech support if more information is needed.

<i>Pluto Model</i>	<i>ETX Module</i>	<i>Processor Type</i>	<i>Processor Clock</i>	<i>SO-DIMM DRAM</i>	<i>Operating Temperature</i>
<b>PLT-3845B-XT-8G</b>	ETX-3845-01	Intel E3845 quad core	1.91GHz	8GB	-40°C to +85°C
<b>PLT-3845B-XT-4G</b>	ETX-3845-01	Intel E3845 quad core	1.91GHz	4GB	-40°C to +85°C
<b>PLT-3845B-XT-2G</b>	ETX-3845-01	Intel E3845 quad core	1.91GHz	2GB	-40°C to +85°C

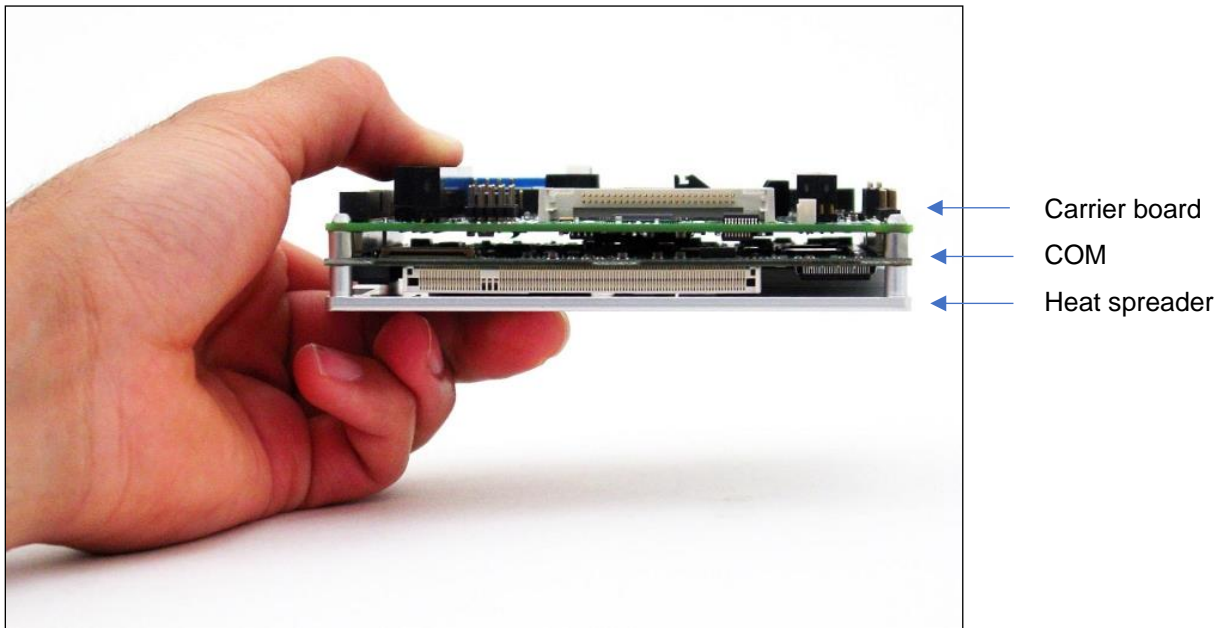

**Figure 1: Edge View of the Pluto Embedded Platform**

Pluto’s features comprise functions provided by the “Pluto baseboard” (top board in stack shown in Figure 1) along with functions implemented on the attached ETX computer-on-module (COM) macrocomponent (bottom board in stack), along with a heat-spreader (or heatsink) mounted on the bottom.

## 1.1 ETX Computer-on-Module (COM) Features

**Note:** The ETX COM features listed here are typical. Refer to the appropriate ETX CPU module's user manual for detailed specifications.

- Processor: Intel E3845 quad core Bay Trail CPU
- RAM: 200-pin SO-DIMM socket; supports up to 8GB DDR3 SDRAM
- Graphics:
  - VGA CRT interface
  - LCD flat panel interface (LVDS); provides LCD backlight control signals
  - TV output
  - SDVO interface (connector directly on ETX module)
- Audio: AC'97 CODEC; mic in, line in/out signals
- 1 IDE interface:
  - Supports two devices (Master/Slave)
  - Usable in PIO or UDMA mode
- 2 SATA (Serial ATA) interfaces
  - Support one device each
  - Connectors directly on ETX COM module
- Floppy/parallel port: shared interface
- Ethernet interface: 1 10/100Base-T port (Realtek 8103EL)
- 2 serial ports; 1 RS-232/422/485, 1 RS-232 only
- Keyboard/mouse: PS/2 ports; USB also usable for keyboard/mouse
- 4 USB 2.0 ports
- Other: SMBus, IrDA serial interfaces; PC speaker interface; watchdog timer
- Dual system expansion buses: 16-bit ISA and 32-bit PCI
- ETX 3.0 compliant form-factor (physical and electrical)

## 1.2 Pluto Baseboard Features

- Additional Ethernet interface: Gigabit Ethernet using AX88179
- 2 additional RS-232 serial ports using FT2232 USB to Serial converter chip
- Digital I/O: 8 logic-level digital inputs and outputs
  - Inputs:  $V_{IH} = 2V$ ,  $V_{IL} = 0.8V$ , input clamp current =  $-18mA$
  - Outputs:  $V_{OMax} = 5V$ ,  $V_{OMin} = 0V$ , output clamp current =  $20mA$
- On-board piezoelectric PC speaker
- ATX-style power input and system control using screw terminals
- On-board RTC backup battery
- ETX COM socket on bottom; conforms to ETX v3.0 specification
- I/O connectors provided for all system I/O
- On-board CompactFlash socket; configurable as IDE Master or Slave
- On-board PC/104-Plus socket; supports ISA and PCI expansion buses
- Operating temperature:  $-40^{\circ}C$  to  $+85^{\circ}C$  ( $-40^{\circ}F$  to  $+185^{\circ}F$ )
- Form-factor: ETX footprint (4.5 x 3.7 in. / 114 x 95mm)

---

### 1.3 Thermal Considerations and Heatspreader

Pluto includes a bottom-mounted heat spreader / mounting plate which serves as a conduction-cooling heat transfer device. However, this heat spreader by itself does not constitute the complete thermal solution necessary for any specific implementation, but provides a common interface between the single board computer and the customer's implementation-specific thermal solution.

The outside surface of the Pluto heatspreader must be kept at a temperature not to exceed +85°C. If your environment causes the temperature on the outside surface of the heatspreader to exceed the appropriate temperature, you are responsible for removing the additional heat from the system through either an additional passive thermal solution or fan solution.

Pluto's integrated heatspreader makes thermal contact with the heat generating components and provides a flat surface on the bottom of the assembly for mating to the system enclosure. This technique facilitates efficient removal of heat from the COM module without the need for a fan. Four mounting holes on the bottom of the conduction cooled heatspreader are provided to mount Pluto in an enclosure or to a bulkhead. These mounting holes are #6-32 threaded holes on 2.8" centers.

## 2. FUNCTIONAL OVERVIEW

### 2.1 Block Diagrams

Pluto consists of a 2-board assembly, COM + carrier board. The COM provides the CPU and core I/O circuitry, while the carrier board provides the remaining peripheral I/O details, power supplies, and I/O connectors. The block diagrams for both boards are given below. The complete system block diagram is derived by combining the two separate diagrams together at the ETX connectors X1-X4.

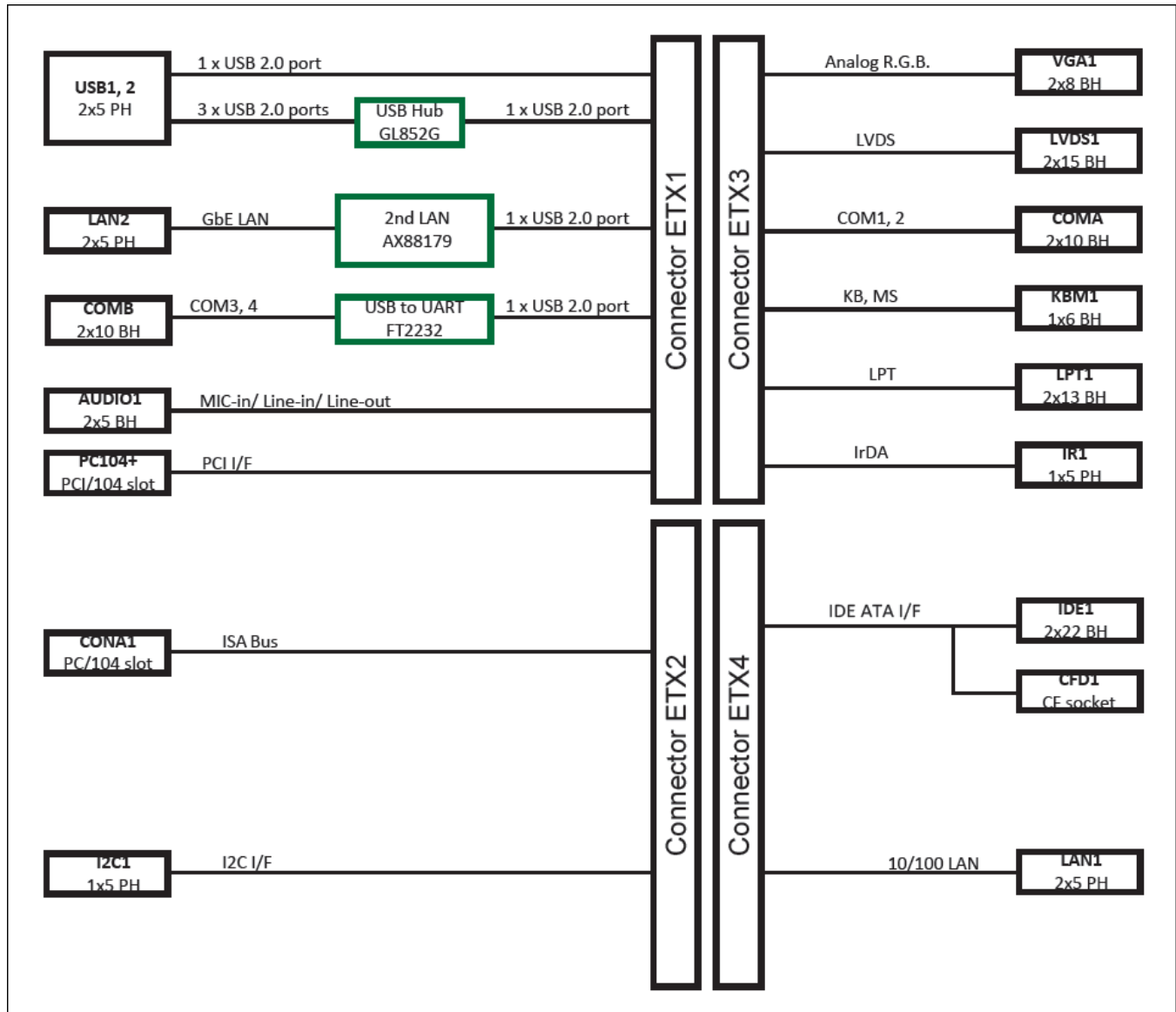

Figure 2: Pluto Carrier Block Diagram



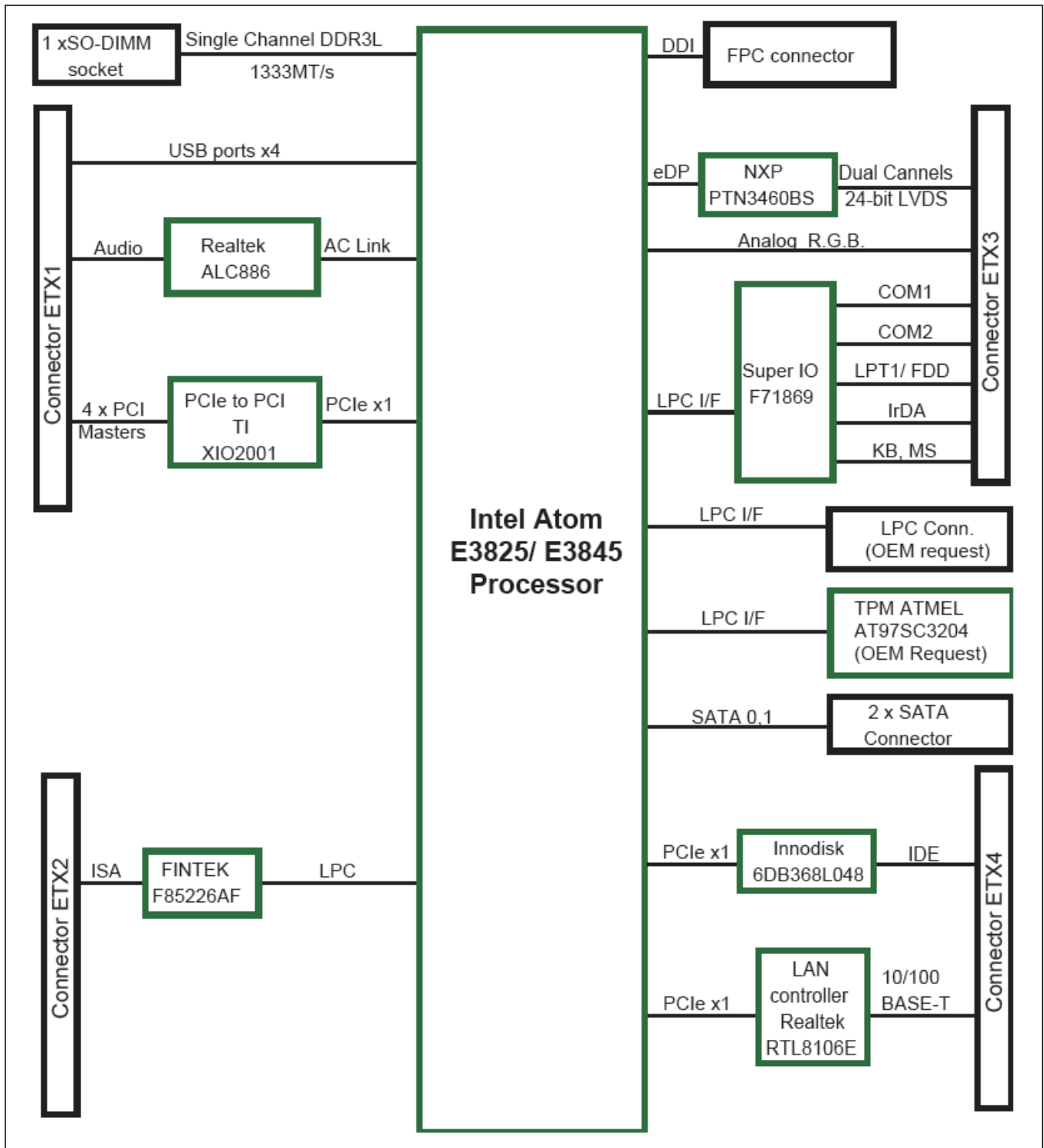

Figure 3: ETX CPU Module Block Diagram

## 2.2 Baseboard Dimensions

Figure 4 shows the overall dimensions of the Pluto baseboard.

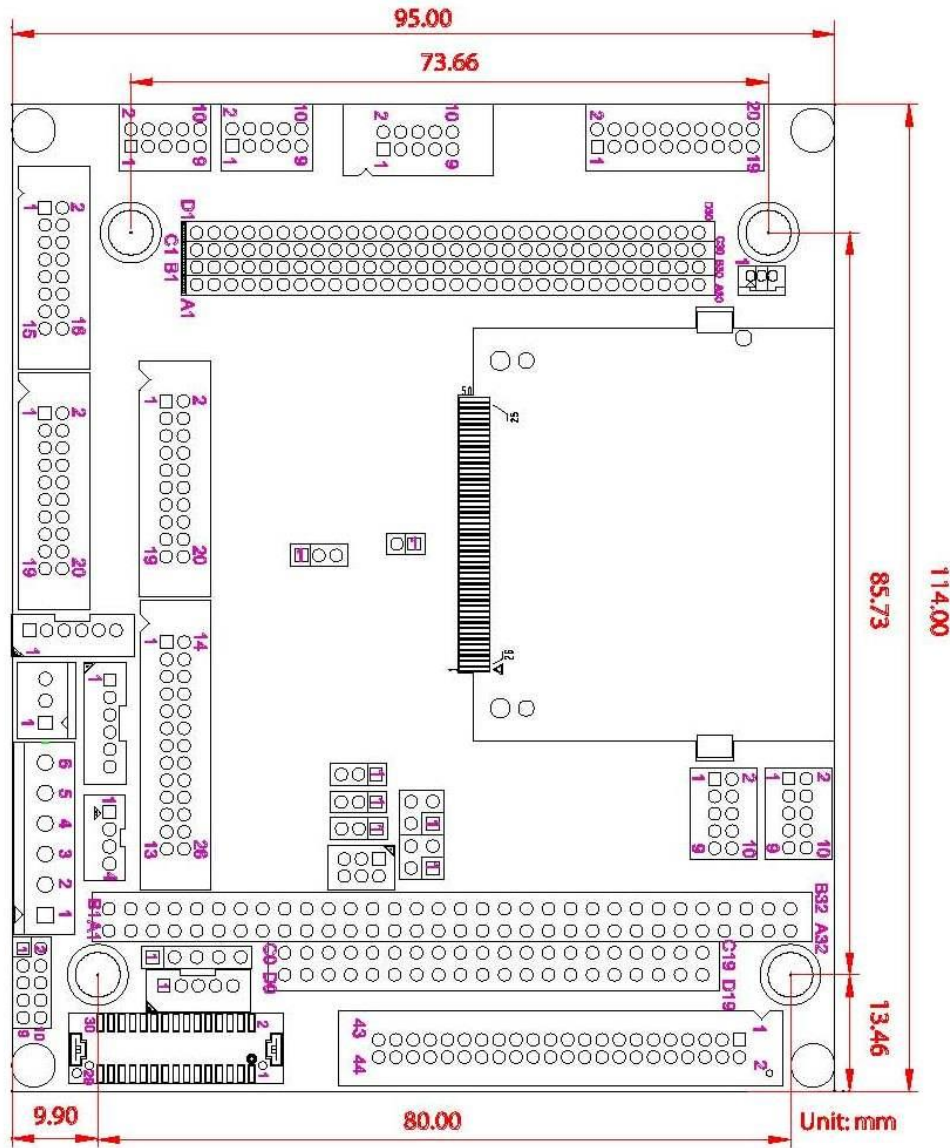

Figure 4: Baseboard Dimensions

### 2.3 Baseboard Connectors and Jumpers

The diagram in Figure 5 illustrates the position of interface and bus connectors and configuration jumpers located on the top side of the Pluto baseboard. Pluto's ETX CPU module plugs into four high-density connectors on the baseboard's bottom side, and is secured via screws and standoffs to the baseboard's four corner mounting holes.

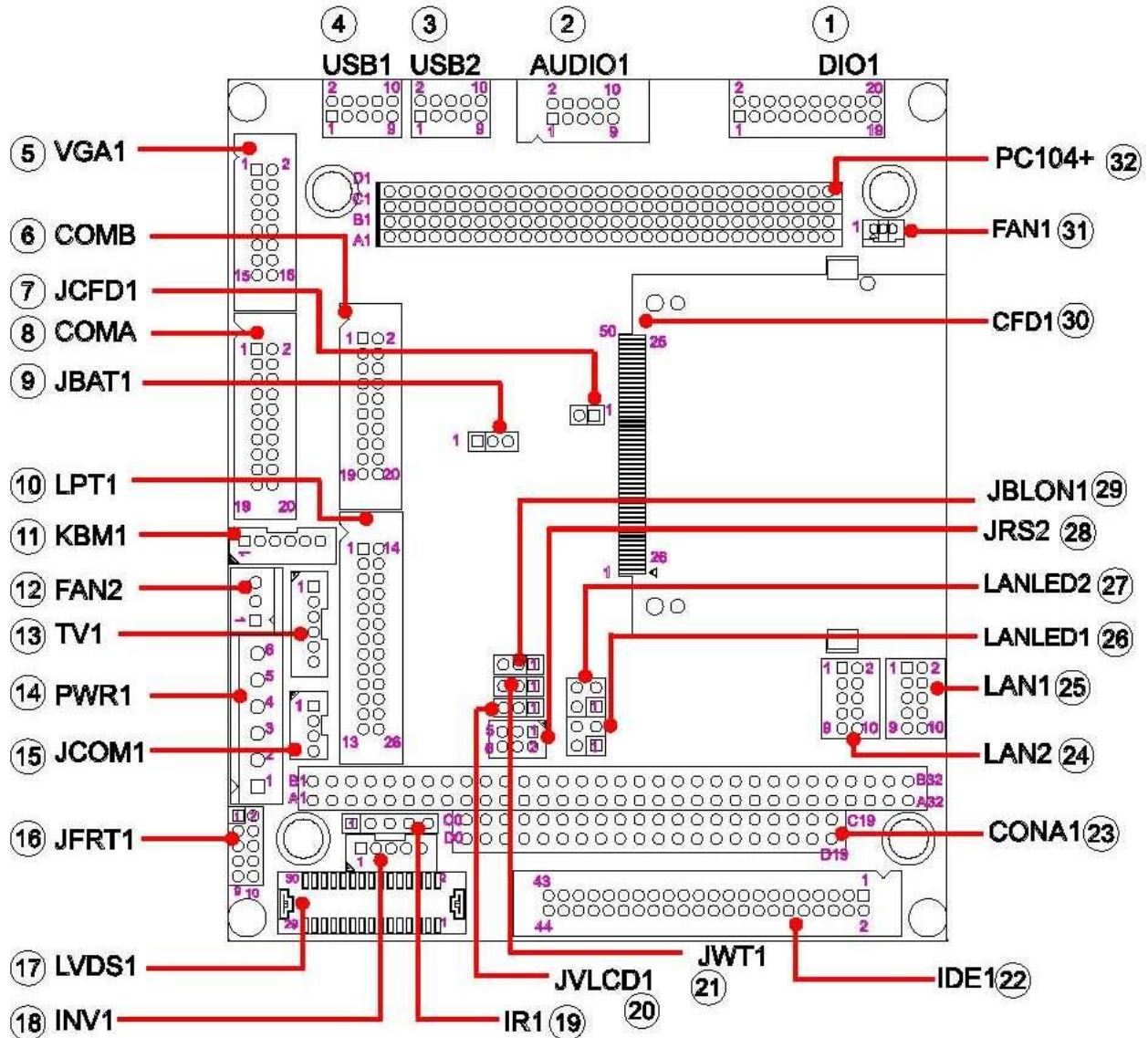

Figure 5: Baseboard Connectors and Jumpers

## 2.4 Interface Connector Summary

The following table summarizes the functions of Pluto's interface, utility, and power connectors. The table also identifies which major subsystem – ETX CPU module or Pluto baseboard – provides the electronics associated with each connector.

Signal functions relating to all of Pluto's interface connectors are discussed in greater detail in Section 4 of this document. Diamond offers an optional Pluto Cable Kit, which provides mating cable assemblies for most of Pluto's I/O interface connectors. The table below indicates which of Pluto's interfaces connectors are supported by the Pluto Cable Kit.

<b>Interface Function</b>	<b>Connector Designation</b>	<b>Associated Subsystem</b>	<b>Supported by Cable Kit?</b>
Audio	AUDIO1	ETX module	Yes
COM1-COM2 RS-232	COMA	ETX Module	Yes
COM3-COM4 RS-232	COMB	Baseboard	Yes
COM2 RS-422/485	JCOM1	ETX and baseboard	
CompactFlash Socket	CFD1	ETX module	
DC Power Input	PWR1	Various	Yes
Digital I/O	DIO1	Pluto baseboard	
Ethernet LAN Interface	LAN1	ETX module	Yes
Ethernet LAN Interface	LAN2	Baseboard	Yes
Ethernet Status LEDs	LANLED1, LANLED2	ETX and baseboard	
Fan Power	FAN1, FAN2	ETX module	
IDE	IDE1	ETX module	Yes
Infrared Interface	IR1	ETX module	
LCD Inverter Interface	INV1	Pluto baseboard	
LCD LVDS Out	LVDS1	ETX module	
PC/104-Plus ISA bus	CONA1	ETX module	
PC/104-Plus PCI bus	PC104+	ETX module	
Printer/Floppy	LPT1	ETX module	Yes
PS/2 Keyboard/Mouse	KBM1	ETX module	Yes
SATA interfaces	SATA1, SATA2	On ETX module	Yes
Serial Digital Video Output	SDVO	On ETX module	
TV Out	TV1	ETX module	Yes
USB1-USB4	USB1, USB2	ETX module	Yes
Utility Signals	JFRT1	ETX and baseboard	
VGA Video Out	VGA1	ETX module	Yes

## 2.5 Configuration Jumper Summary

The Pluto baseboard's configuration jumpers are listed below. Details regarding the use of these jumpers appear in Section 5 of this document.

<b><i>Jumper</i></b>	<b><i>Description</i></b>
JBAT1	CMOS Setup clear
JRS2	COM2 RS-232/422/485 mode select
JCFD1	CompactFlash IDE mode
JVLCD1	LCD panel voltage select
JWT1	Watchdog timer mode
JBLON1	LCD Backlight select

### 3. GETTING STARTED

First-time Pluto users normally receive the product as part of Diamond’s Pluto Development Kit, which provides everything needed to ensure rapid application development. This section of the Pluto User Manual covers basic hardware setup, power connection, system boot-up, and initial software configuration. After Pluto is up and running, refer to the later sections of this manual for the detailed hardware and software reference information needed to adapt the product to specific applications.

Important Safe-Handling Information



**WARNING: ESD-Sensitive Electronic Equipment!**

Observe ESD-safe handling procedures when working with this product.

Always use this product in a properly grounded work area and wear appropriate ESD-preventive clothing and/or accessories.

Always store this product in ESD-protective packaging when not in use.

Please refer to page 3 of this manual (“Important Safe-Handling Information”) for further details.

#### 3.1 Introducing the Pluto Development Kit

The Pluto Development Kit provides everything required for Pluto-based rapid application development. The table below lists the boards, cables, and other items included in the Development Kit.

<i>Item</i>	<i>Diamond P/N</i>	<i>Description</i>
1		Pluto SBC
2	C-PLT-KIT	Pluto Cable Kit
3	MTG104	PC/104 Mounting Kit
4	DOC-PKG	DSC Documentation Package
5		Pluto Quick Start Guide

### 3.1.1 Pluto Cable Kit

The Pluto Cable Kit provides convenient access to all of Pluto's I/O features. The kit's 15 cable assemblies are shown in the photo below, and identified in the table that follows.

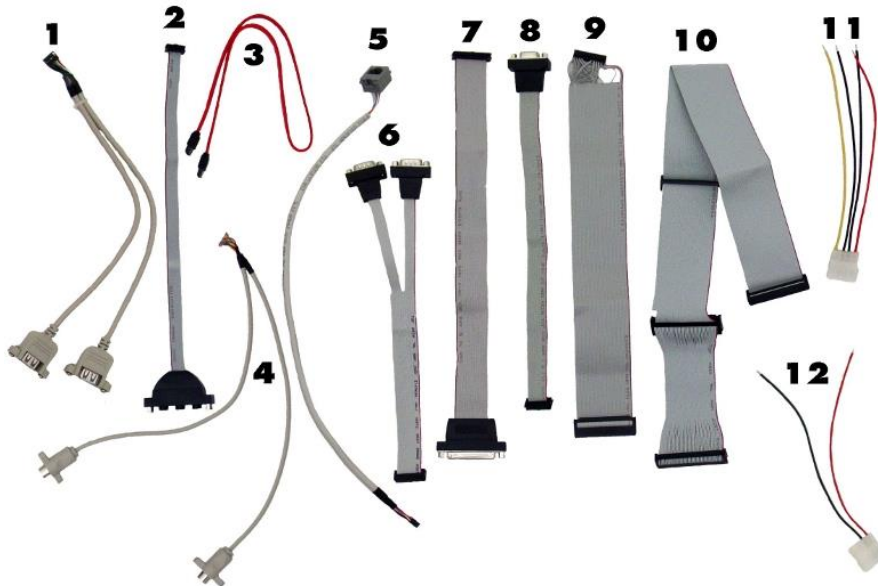

**Note:** On each interface cable, the end of the cable connector that has a red wire going to it should be oriented toward the end of the board connector that is labeled "pin 1" (refer to Figure 3 in Section 2 of this manual for an illustration showing the location and orientation of all of the Pluto Baseboard's interface connectors).

Item	Qty	Diamond P/N	Description	Connects to...
1	2	6989007	Dual USB	USB1, USB2
2	1	6989004	Audio in/out	AUDIO1
3	2	6989012	SATA data	ETX module
4	1	6989011	PS/2 keyboard/mouse	KBM1
5	2	6989015	Ethernet RJ-45	LAN1, LAN2
6	2	6989008	Dual serial RS-232	COMA, COMB
7	1	6989006	Parallel	LPT1
8	1	6989010	VGA	VGA1
9	1	6989001	Floppy	LPT1
10	1	6989005	IDE data	IDE1
11	1	6989002	DC power (4-wire)	PWR1
12	1	6989003	DC power (2-wire)	PWR1

## 3.2 System Setup

This section outlines a simple process for preparing Pluto for first-time operation. Additional details regarding Pluto's interface functions and connections may be found in Section 4 of this document ("Interface Connector Details") and from the attached ETX CPU module's user manual.

### 3.2.1 Display

Pluto provides both VGA monitor and LVDS flat panel display interfaces. Recognizing the complexities associated with connection to parallel-interfaced flat panels, this quick-start process assumes the use of a standard VGA-compatible monitor (LCD or CRT). Plug the VGA interface cable into VGA1 on the baseboard, and connect a VGA-compatible display to the female DB15 connector on its free end.

### 3.2.2 Keyboard and Mouse

Pluto supports operation using either PS/2- or USB-based keyboard and mouse devices. Plug the desired interface cable (PS/2 or USB) from the Pluto Cable Kit into the designated connector on the baseboard (KBM1, USB1, or USB2). Then plug the keyboard and mouse interface cables into the mating connectors on the Pluto interface cables.

### 3.2.3 Mass Storage Devices

Next, connect Pluto to IDE or SATA hard drive and CD-ROM drives. Depending on the ETX CPU module attached to your Pluto boardset, Pluto can operate with a combination of both IDE and SATA drives – both hard drives and CD-ROMs – and can boot from any of them.

- **IDE drives** -- For IDE drive connection, plug the 40-conductor IDE flat ribbon cable from the Cable Kit into IDE1 of the Pluto baseboard, and plug the IDE cable's female connectors into either or both drives' male data connectors. If an IDE hard drive is used, jumper the drive as the "Master" IDE device using a jumper block on the drive (consult the drive's documentation for details). If a second drive is to be connected to the IDE interface cable, be sure to jumper it as the IDE "Slave" device.
- **SATA drives** – For SATA drive connection, plug the SATA interface cable from the Cable Kit into one of the SATA connectors on the ETX CPU module. Refer to the ETX module's User Manual for details on its SATA interface support and connector location.

**Caution!** Be sure the system power supply is disconnected from its AC power source prior to performing the following step...

### 3.2.4 Connecting Power

Depending on your Pluto setup's power requirements, attach the tinned wires of either the 2-wire (+5V only) or 4-wire (+5V and +12V) DC power cable assemblies (items 11 and 12) to the power input terminal block (PWR1) on the baseboard. +12V DC power input is not required by either the Pluto baseboard or the attached ETX CPU module; it is only needed if required by add-on or external devices, including:

- Modules plugged into the PC/104-Plus socket that require +12V from the ISA or PCI buses
- An external LCD backlight power supply powered by connector INV1
- An auxiliary cooling fan powered with +12V through connector FAN2
- External circuitry obtaining +12V power via DIO1 (the Digital I/O port)

**Caution!** Be sure to connect the 2- and 4-wire baseboard DC cable assemblies' yellow wire (+12V) to pin 1, the black wires (ground) to pins 2, 3, and 4, and the red wires (+5VDC) to pins 5 and 6 of PWR1.

After attaching the desired DC power cable (2- or 4-wire) to the Pluto baseboard's power input terminal block, plug the power cable's 4-pin male connectors into the female connector an ATX-style (or equivalent) power supply's 5.25-inch disk drive power cable.



Connect additional disk drive power cables from the power supply to the system's IDE or SATA disk drives.

### 3.2.5 Installing Pluto in an Enclosure

Install the Pluto single board computer in an enclosure that has an appropriate mounting-hole pattern (2.8" square).

Pluto's heatspreader has four #6-32 threaded holes on 2.8" centers for mounting. Select four #6-32 threaded screws of the proper length and head type to work with your enclosure. Allow a minimum of 0.20" and maximum of 0.30" screw length for insertion into Pluto's heatspreader. The total screw length will depend on the thickness of your enclosure wall.

## 3.3 Booting the System

Power-up the VGA video monitor. Then power-up the system power supply. Pluto should begin its boot-up sequence immediately, as evidenced by BIOS messages on the connected VGA display. You can run the BIOS Setup utility and proceed to install an operating system on the boot drive just as you would on a normal desktop PC.

**Note:** *This process may vary according to the specific ETX CPU module attached to Pluto's bottom side. Please refer to the particular ETX module's user manual for further details*

### 3.3.1 BIOS Setup

The Pluto ETX CPU module's BIOS ROM provides a wide range of configuration options. When you power up Pluto for the first time, you should immediately enter the BIOS "Setup" utility in order to adjust BIOS settings to match your system's peripheral devices and other requirements and to configure various other hardware and software parameters.

Options configurable via Setup typically include:

- Number and type of mass storage devices
- Boot device priority
- Video display type and resolution
- IDE, serial, and parallel interface modes and protocols
- PCI and PnP configuration
- Power management setup
- Automatic power-up after LAN connection, RTC alarm, power resumption, etc.
- System monitoring and security functions

The precise configuration options available via the BIOS Setup utility – and the specific keystroke sequence required to launch Setup on power-up – vary according to the specific ETX CPU module attached to the Pluto Baseboard. Refer to the ETX CPU module's user manual for further details.

### 3.3.2 Operating System Drivers

Depending on the operating system to be installed on your Pluto setup, it may be necessary to install software drivers for on-board interface controllers. The driver requirements (if any) will depend on both the Pluto Baseboard and the attached ETX CPU module. Drivers for Windows XP and Linux 2.6, if required, are included on the Software and Documentation CD that is included in the Pluto Development Kit. This software is also available for download from Diamond's website.

## 4. INTERFACE CONNECTOR DETAILS

This section describes the functions associated with the Pluto baseboard's PC/104-*Plus* bus expansion stack, utility, I/O interface, and power connectors in greater detail. Section 3.1.1 contains a list of ready-to-use interface cables included in Diamond's Pluto Cable Kit.

Many of the signals present on Pluto's interface connectors are derived directly from signals on the attached ETX CPU module's high density ETX bus connectors. Please refer to the particular ETX module's user manual for further details on the definition and utilization of these signals. Additional information on these signals appears in the ETX 3.0 specification, which is available from the ETX Industrial Group's website (<http://www.etx-ig.de/specs/specs.php>). Also available from that site is the latest ETX Design Guide, which provides further details on the ETX connector signal functions and interface considerations. Several other relevant specifications are referenced below.

### 4.1 PC/104-*Plus* stacking location (CONA1, PC104+)

These connectors accommodate the addition of either PC/104 (ISA bus only), PC/104-*Plus* (ISA and PCI buses), or PCI-104 (PCI bus only) modules on top of the Pluto baseboard. Specifications and other details on all three of these expansion module standards are available from the website of the PC/104 Consortium (<http://www.pc104.org>).

#### 4.1.1 PC/104-*Plus* ISA Bus (CONA1)

The 64- and 40-pin header connectors in location CONA1 carry the PC/104-*Plus* expansion stack location's 104-pin ISA bus signals. These signals, generated by Pluto's ETX CPU module, are essentially identical in function and signaling to those of the 16-bit PC/AT bus, except for the physical design.

A 64-pin header incorporates the 8-bit "PC bus" connector signals, while a 40-pin header incorporates additional signals associated with the full 16-bit "PC/AT bus." The signal names and functions for CONA1 are listed in the table on the following page.

**Note:** *The Pluto baseboard does not provide a means for supplying -5V or -12V DC power to the PC/104-Plus ISA bus. Most PC/104 and PC/104-Plus modules do not require these voltages to be supplied by the bus.*

IOCHCHK-	A1	B1	GND	GND	C0	D0	GND
SD7	A2	B2	RESETDRV	SBHE-	C1	D1	MEMCS16--
SD6	A3	B3	+5V	LA23	C2	D2	IOCS16-
SD5	A4	B4	IRQ9	LA22	C3	D3	IRQ10
SD4	A5	B5	-5V (N/C)	LA21	C4	D4	IRQ11
SD3	A6	B6	DRQ2	LA20	C5	D5	IRQ12
SD2	A7	B7	-12V (N/C)	LA19	C6	D6	IRQ15
SD1	A8	B8	ENDXFR-	LA18	C7	D7	IRQ14
SD0	A9	B9	+12V	LA17	C8	D8	DACK0-
IOCHRDY	A10	B10	Key (no pin)	MEMR-	C9	D9	DRQ0
AEN	A11	B11	SMEMW-	MEMW-	C10	D10	DACK5-
SA19	A12	B12	SMEMR-	SD8	C11	D11	DRQ5
SA18	A13	B13	IOW-	SD9	C12	D12	DACK6-
SA17	A14	B14	IOR-	SD10	C13	D13	DRQ6
SA16	A15	B15	DACK3-	SD11	C14	D14	DACK7-
SA15	A16	B16	DRQ3	SD12	C15	D15	DRQ7
SA14	A17	B17	DACK1-	SD13	C16	D16	+5
SA13	A18	B18	DRQ1	SD14	C17	D17	MASTER-
SA12	A19	B19	REFRESH-	SD15	C18	D18	GND
SA11	A20	B20	SYSCLK	Key (no pin)	C19	D19	GND
SA10	A21	B21	IRQ7				
SA9	A22	B22	IRQ6				
SA8	A23	B23	IRQ5				
SA7	A24	B24	IRQ4				
SA6	A25	B25	IRQ3				
SA5	A26	B26	DACK2-				
SA4	A27	B27	TC				
SA3	A28	B28	BALE				
SA2	A29	B29	+5V				
SA1	A30	B30	OSC				
SA0	A31	B31	GND				
GND	A32	B32	GND				

#### 4.1.2 PC/104-Plus PCI Bus (PC104+)

The Pluto baseboard's PC/104-Plus PCI expansion bus signals are generated by the ETX CPU module, and are essentially identical in function and signaling to a normal PC motherboard's 32-bit PCI bus except for the physical connector, a 120-pin header (PC104+) arranged as four 30-pin rows.

**Note:** The Pluto baseboard can supply +3.3V DC at up to 1A to the PC/104-Plus PCI bus.

GND/5.0	A1	B1	Reserved	+5V	C1	D1	AD00
VI/O	A2	B2	AD02	AD01	C2	D2	+5V
AD05	A3	B3	GND	AD04	C3	D3	AD03
CMD/BE0	A4	B4	AD07	GND	C4	D4	AD06
GND	A5	B5	AD09	AD08	C5	D5	GND
AD11	A6	B6	VI/O	AD10	C6	D6	M66EN
AD14	A7	B7	AD13	GND	C7	D7	AD12
+3.3V	A8	B8	CMD/BE1-	AD15	C8	D8	+3.3V
SERR-	A9	B9	GND	SB0-	C9	D9	PAR
GND	A1	B1	PERR-	+3.3V	C1	D1	SDONE
STOP-	A1	B1	+3.3V	LOCK-	C1	D1	GND
+3.3V	A1	B1	TRDY-	GND	C1	D1	DEVSEL-
FRAME-	A1	B1	GND	IRDY-	C1	D1	+3.3V
GND	A1	B1	AD16	+3.3V	C1	D1	CMD/BE2-
AD18	A1	B1	+3.3V	AD17	C1	D1	GND
AD21	A1	B1	AD20	GND	C1	D1	AD19
+3.3V	A1	B1	AD23	AD22	C1	D1	+3.3V
IDSEL0	A1	B1	GND	IDSEL1	C1	D1	IDSEL2
AD24	A1	B1	CMD/BE3	VI/O	C1	D1	IDSEL3
GND	A2	B2	AD26	AD25	C2	D2	GND
AD29	A2	B2	+5V	AD28	C2	D2	AD27
+5V	A2	B2	AD30	GND	C2	D2	AD31
REQ0-	A2	B2	GND	REQ1-	C2	D2	VI/O
GND	A2	B2	REQ2-	+5V	C2	D2	GNT0-
GNT1-	A2	B2	VI/O	GNT2-	C2	D2	GND
+5V	A2	B2	CLK0	GND	C2	D2	CLK1
CLK2	A2	B2	+5V	CLK3	C2	D2	GND
GND	A2	B2	INTD-	+5V	C2	D2	RST-
+12V	A2	B2	INTA-	INTB-	C2	D2	INTC-
-12V	A3	B3	Reserved	Reserv	C3	D3	GND/3.3V Key

## 4.2 USB1-USB4 (USB1, USB2)

Connectors USB1 and USB2 each provide access to two of Pluto's four USB 2.0 compatible interface ports. The two connectors have identical pinouts.

+5V	1	2	+5V
USBD-	3	4	USBD-
USBD+	5	6	USBD+
GND	7	8	GND
GND	9	10	Key

## 4.3 Audio (AUDIO1)

Connector AUDIO1 provides access to Pluto's AC'97 stereo audio input and output signals.

Line in, left	1	2	Line in, right
GND	3	4	GND
Mic input	5	6	(unused)
GND	7	8	GND
Speaker out, left	9	10	Speaker out, right

## 4.4 Digital I/O (DIO1)

Connector DIO1 provides eight digital inputs and eight digital outputs. DIO1's digital inputs and outputs provide 5V CMOS logic levels. The I/O read (data input) address is 0x200, while the I/O write (data output) address is 0x208. DIO1 pins 19 and 20 can supply up to 1A each of +5V and +12V DC power for use by external circuitry connected to this port.

DO0	1	2	DO1
DO2	3	4	DO3
DO4	5	6	DO5
DO6	7	8	DO7
GND	9	10	GND
DI0	11	12	DI1
DI2	13	14	DI3
DI4	15	16	DI5
DI6	17	18	DI7
+5V	19	20	+12V

## 4.5 CPU Fan Power (FAN1)

Connector FAN1 provides +5V DC for powering the ETX module's optional CPU cooling fan. The power source for this connector is the Pluto Baseboard's DC Power input connector.

1	N/C
2	+5V
3	GND

## 4.6 CompactFlash Socket (CFD1)

Socket CFD1 is a standard 50-pin CompactFlash (CF) Type I/II card socket. This connects to Pluto's Primary IDE port in parallel with IDE connector IDE1. A jumper option (JCFD1) configures the CF socket to be the Master or Slave (default) IDE device.

GND1	1	26	(unused)
D3	2	27	D11
D4	3	28	D12
D5	4	29	D13
D6	5	30	D14
D7	6	31	D15
CE1	7	32	CE2
A10	8	33	(unused)
OE	9	34	IORD-
A9	10	35	IOWR-
A8	11	36	(unused)
A7	12	37	RDY
VCC	13	38	VCC
A6	14	39	CSEL
A5	15	40	(unused)
A4	16	41	RESET-
A3	17	42	WAIT
A2	18	43	INPACK
A1	19	44	REG
A0	20	45	ACT_SLV
D0	21	46	PDIAG
D1	22	47	D8
D2	23	48	D9
IOCS16	24	49	D10
GND25	25	50	CD2

## 4.7 Ethernet Status LEDs (LANLED1, LANLED2)

Connectors LANLED1 and LANLED2 provide signals for adding optional LAN status LEDs to Pluto's two 10/100Mbps Ethernet ports. LANLED2 supports the Ethernet controller located on the Pluto Baseboard, while LANLED1 supports ETX CPU module's controller. Both connectors have identical pinouts.

Activity LED-	1	2	Activity LED+
Link LED-	3	4	Link LED+

## 4.8 Ethernet LAN Interfaces (LAN1, LAN2)

Connectors LAN1 and LAN2 carry the data signals from Pluto's two 10/100Mbps Ethernet interfaces. LAN1 is associated with the Ethernet controller located on the ETX CPU module, while LAN2 provides the interface to an Realtek 8103EL controller located on the Pluto Baseboard. Connectors LANLED1 and LANLED2 may optionally be used for adding LAN status LEDs to either or both Ethernet ports. Connectors LAN1 and LAN2 have identical pinouts.

TX+	1	2	TX-
RX+	3	4	(unused)
(unused)	5	6	RX-
(unused)	7	8	(unused)
GND	9	10	Key

## 4.9 IDE (IDE1)

Connector IDE1 carries the Primary IDE port signals from the ETX CPU module. This port can be used for connection of two drives, configured as IDE Master and Slave, daisy-chained on a single 44-conductor ribbon cable. The Pluto Baseboard's CF socket (CFD1), which connects in parallel to this set of signals, can be configured (via jumper JCFD1) to be either the Master or Slave IDE device.

**Note:** The signals on this connector's pins are defined by the attached ETX CPU module. Please refer to the particular ETX module's user manual for further details on the definition and utilization of these signals.

RESET#	1	2	GND
DATA7	3	4	DATA8
DATA6	5	6	DATA9
DATA5	7	8	DATA10
DATA4	9	10	DATA11
DATA3	11	12	DATA12
DATA2	13	14	DATA13
DATA1	15	16	DATA14
DATA0	17	18	DATA15
GND	19	20	N/C
DREQ	21	22	GND
IOW#	23	24	GND
IOR#	25	26	GND
IRDY	27	28	IDSEL
ACK#	29	30	GND
IRQ	31	32	N/C
AD1	33	34	ATA66 DETECT
AD0	35	36	AD2
CS#2	37	38	CS#3
ACT#	39	40	GND
+5V	41	42	+5V
GND	43	44	GND



## 4.10 Infrared Interface (IR1)

Connector IR1 provides a bidirectional serial data interface for use with an external infrared transceiver.

1	+5V
2	(unused)
3	Receive Data
4	GND
5	Transmit Data

## 4.11 LCD Inverter Interface (INV1)

Connector INV1 provides +12V and backlight control signals for use with an external LCD panel. The +12V power supplied to this connector passes through from the Pluto Baseboard's DC Power input connector (PWR1).

The backlight power on/off pin is controlled by the display controller chip on the attached ETX CPU module, according to power management control configured via the BIOS Setup and the operating system in use. The effect of the brightness control signal will vary according to the LCD panel and backlight inverter board being used.

**Note:** The control signals (BLON-, BIASON) on this connector's pins are routed from the attached ETX CPU module's ETX3 connector. Please refer to the particular ETX module's user manual for further details on the definition and utilization of these signals.

1	+12V
2	GND
3	BLON-
4	BIASON
5	GND

<b>Signal Name</b>	<b>Signal Function</b>	<b>Direction</b>
BLON-	LCD backlight power on/off	Output
BIASON	LCD brightness control	Output
+12V	LCD backlight inverter power	Output
GND	Ground	n/a

## 4.12 LCD LVDS Out (LVDS1)

Connector LVDS1 provides access to LVDS (low-voltage differential signaling) display interface signals that originate Pluto's ETX CPU module. Each clock and data signal consists of a differential pair (e.g. TX1CLK+ and TX1CLK-). VDD is either +3.3V or +5V, depending on the setting of a configuration jumper (JVLC1) on the Pluto Baseboard.

**Note:** The signals on this connector's pins are defined by the attached ETX CPU module. Please refer to the particular ETX module's user manual for further details on the definition and utilization of these signals.

VDD	2	1	VDD
TX2CLK+	4	3	TX1CLK+
TX2CLK-	6	5	TX1CLK-
GND	8	7	GND
TX2D0+	10	9	TX1D0+
TX2D0-	12	11	TX1D0-
GND	14	13	GND
TX2D1+	16	15	TX1D1+
TX2D1-	18	17	TX1D1-
GND	20	19	GND
TX2D2+	22	21	TX1D2+
TX2D2-	24	23	TX1 D2-
GND	26	25	GND
TX2D3+	28	27	TX1D3+
TX2D3-	30	29	TX1 D3-

### 4.13 Utility Signals (JFRT1)

This connector provides interface signals for use with various “front panel” switches and indicators.

RESET+	1	2	RESET-
POWER_LED+	3	4	POWER_LED-
HDD_LED+	5	6	HDD_LED-
SPEAKER+	7	8	SPEAKER-
NC	9	10	GND

<b>Signal Name</b>	<b>Signal Function</b>	<b>Direction</b>
RESET	Active low reset input; connects to “Power Good” input on ETX CPU module	Input
POWER_LED	Power on indicator	Output
HDD_LED	HDD access indicator	Output
SPEAKER	PC speaker output (connects in parallel with onboard buzzer)	Output

### 4.14 COM2 RS-422/485 Interface (JCOM1)

Connector JCOM1 provides access to the COM2 serial port’s transmit and receive data when the port is configured for either RS-422 or RS-485 serial protocols. The signals present on each of the connector’s four pins for these two modes are listed in the table below. COM2’s serial protocol mode is selected using configuration jumpers located at position JRS2 on the Pluto Baseboard. When the port is configured for RS-232 mode, its interface appears at connector COMA instead of JCOM1.

<b>Pin</b>	<b>RS-422 Mode Signal</b>	<b>RS-485 Mode Signal</b>
1	TX+	DATA+
2	TX-	DATA-
3	RX+	N/C
4	RX-	N/C

## 4.15 DC Power Input (PWR1)

Connector PWR1 is a screw-terminal block through which Pluto receives its +5V and +12V DC power. Pluto, itself, only requires +5V DC input for its operation.

PWR1's "pass-through" +12V power input is available for use in powering PC/104-*Plus* modules or other external peripherals requiring it. It routes to...

- The PC/104-*Plus* socket (IDE1/PC104+), for powering optional add-on modules requiring +12V from the ISA or PCI bus
- The external LCD Inverter connector (INV1), for powering an optional LCD backlight supply
- The auxiliary cooling fan connector (FAN2), for powering an optional +12V fan
- The Digital I/O port connector (DIO1), for use by optional external circuitry

1	+12V
2	GND
3	GND
4	GND
5	+5V
6	+5V

<b>Signal Name</b>	<b>Signal Function</b>
+5V	+5V DC main input power. Range should be +4.75V to +5.25V DC measured at this connector
+12V	Pass-through power for +12V powered add-on modules and external peripherals devices including cooling fans, modules on the PC/104- <i>Plus</i> stack, and LCD backlight. Range should be +11.9V to +13.5V measured at this connector.
GND	0-V (ground) power return path.

## 4.16 TV Out (TV1)

Connector TV1 provides access to the Pluto's TV Out video signals, which originate on the attached ETX CPU module. The 6-pin connector supports three modes of operation: Composite Video, S-Video, and Component Video. The utilization of this connector's six pins in each of these three modes is tabulated below.

**Note:** The signals on this connector's pins are defined by the attached ETX CPU module. Please refer to the particular ETX module's user manual for further details on the definition and utilization of these signals.

<b>Pin</b>	<b>Signal Function when in Composite Video mode</b>	<b>Signal Function when in S-Video mode</b>	<b>Signal function when in Component Video mode</b>
1	CVBS	(unused)	Pb
2	GND	GND	GND
3	(unused)	Luminance	Y
4	GND	GND	GND
5	(unused)	Chrominance	Pr
6	GND	GND	GND

## 4.17 Auxiliary Fan Power (FAN2)

Connector FAN2 provides power for a fan that operates from +12V DC. This power comes from the Pluto Baseboard's DC Power connector.

1	GND
2	+12V
3	(unused)

## 4.18 PS/2 Keyboard and Mouse (KBM1)

Connector KBM1 provides signals for interfacing with PS/2-compatible keyboard and mouse peripherals. Pluto can also operate with USB keyboard and/or mouse devices.

1	Keyboard data
2	GND
3	Mouse data
4	Keyboard clock
5	+5V out
6	Mouse clock

## 4.19 Parallel/Floppy (LPT1)

Connector LPT1 provides access to Pluto's dual-function parallel/floppy interface. The desired mode (parallel or floppy) must be configured via a BIOS Setup option; refer to the specific ETX CPU module's user manual for initialization details.

The table below lists the signals present on connector LPT1 when configured for the bidirectional parallel port mode. A custom interface cable (provided in the Pluto Cable Kit) is required for connecting between LPT1 and a floppy drive when the interface is configured for floppy mode.

**Note:** The signals on this connector's pins are defined by the attached ETX CPU module. Please refer to the particular ETX module's user manual for further details on the definition and utilization of these signals.

STROBE#	1	14	AFD#
PTD0	2	15	Error#
PTD1	3	16	INIT#
PTD2	4	17	SLIN#
PTD3	5	18	GND
PTD4	6	19	GND
PTD5	7	20	GND
PTD6	8	21	GND
PTD7	9	22	GND
ACK#	10	23	GND
Busy	11	24	GND
PE	12	25	GND
Select	13	26	N/C

## 4.20 COM1-COM4 RS-232 (COMA, COMB)

Connectors COMA and COMB each provide access to two of Pluto's four RS-232 compatible serial ports. COM1 and COM2 are on COMA, while COM3 and COM4 are on COMB. Both connectors have identical pinouts.

COM1, COM3, and COM4 only support RS-232 signaling, whereas COM2 supports RS-232, RS-422, and RS-485, under the control of a jumper option at JRS2. When configured for either RS-422 or RS-485, COM2's serial interface becomes available at connector JCOM1 (described later).

DCD#1/3	1	2	RXD1/3
TXD1/3	3	4	DTR#1/3
GND	5	6	DSR#1/3
RTS#1/3	7	8	CTS#1 / 3
RI#1 / 3	9	10	N/C
DCD#2/ 4	11	12	RXD2/ 4
TXD2/ 4	13	14	DTR#2/ 4
GND	15	16	DSR#2/ 4
RTS#2/ 4	17	18	CTS#2/ 4
RI#2/ 4	19	20	N/C

## 4.21 VGA Video Out (VGA1)

Connector VGA1 provides the ETX CPU module's analog VGA video output signal, for driving a VGA-compatible CRT or LCD monitor.

**Note:** The signals on this connector's pins are defined by the attached ETX CPU module. Please refer to the particular ETX module's user manual for further details on the definition and utilization of these signals.

RED	1	2	GREEN
BLUE	3	4	(unused)
GROUND	5	6	GND
GROUND	7	8	GND
(unused)	9	10	GND
(unused)	11	12	VDDAT
HSYNC	13	14	VSYNC
VDCLK	15	16	(unused)

## 4.22 SATA (SATA1, SATA2)

Connectors SATA1 and SATA2 are located along the edge on the outer surface of the ETX computer-on-module (between the module and the heat spreader). Both connectors are industry standard SATA connectors and both have the same pin out as shown below.

1	GND
2	TX+
3	TX-
4	GND
5	RX-
6	RX+
7	GND

## 4.23 LPC (LPC1)

Connector LPC1 is located on the top of the ETX computer-on-module. It is a Hirose FPC12-14P-P0.5 connector with the pin out as shown below.

LAD0	1	2	LAD1
LAD2	3	4	LAD3
GND	5	6	LFRAME#
INT_SERIRQ	7	8	BUF_PLT_RST#
GND	9	10	PCLK_CONN
GND	11	12	GND
+3.3V	13	14	+3.3V





## 5. CONFIGURATION JUMPER DETAILS

This section explains the use of several jumper options on the Pluto Baseboard.

### 5.1 CMOS Setup Clear (JBAT1)

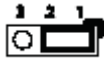
Jumper group JBAT1 provides a means to return the BIOS Setup data to its default state automatically on power-up.



<b>Setting</b>	<b>Mode</b>	
Short 1-2	Keep CMOS (default)	
Short 2-3	Clear CMOS	

### 5.2 COM2 RS-232/422/485 Mode (JRS2)

Jumper group JRS2 configures Pluto's COM2 port for RS-232, RS-422, or RS-485 protocol operation. When in RS-232 mode, COM2's I/O signals are available at interface connector COMA; when in either RS-422 or RS-485 mode, COM2's interface appears at connector JCOM1.

<b>Pins</b>	<b>RS-232 (default)</b>	<b>RS-422</b>	<b>RS-485</b>
1-2	Short	Open	Open
3-4	Open	Short	Open
5-6	Open	Open	Short



		
---	---	---

### 5.3 CompactFlash IDE Mode (JCFD1)

Jumper group JCFD1 enables configuration the Pluto Baseboard's CF socket to be either the Primary Master or Primary Slave IDE device.



The Pluto Baseboard's CF socket (CFD1) and the IDE connector (IDE1) share the system's Primary IDE interface. Therefore only two devices at a time – including a CF card plugged into the CompactFlash socket – can be connected to the system's IDE interface, with one configured as Master and the other as Slave. If additional mass storage peripherals are required, they must be SATA devices connected to the attached ETX CPU module's SATA connectors (assuming the ETX module provides SATA support).

Once the system is operational, use the BIOS Setup utility to configure which drive is to be used for booting the system's operating system.

<i>Setting</i>	<i>Mode</i>	
Short 1-2	Primary Master	
Open	Primary Slave (default)	

### 5.4 LCD Panel Voltage Select (JVLCD1)

Jumper group JVLCD1 must be configured according to the type of LCD panel that will be attached to the Pluto Baseboard's LCD panel interface connector (LVDS1).

<i>Setting</i>	<i>LCD Panel Voltage</i>	
Short 1-2	+5V	
Short 2-3	+3.3V (default)	



### 5.5 LCD Backlight Select (JBLON1)

The LCD panel backlight active mode can be selection by jumper JBLON1 as high or low.

<i>Pin</i>	<i>Mode</i>	
1-2	Active High (Default)	
2-3	Active Low	

## 5.6 Watchdog Timer Mode (JWT1)

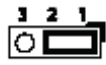
Jumper group JWT1 determines the behavior of Pluto's watchdog timer, as indicated in the table below. In the case of a Reset (2-3 shorted), a watchdog timer time-out condition produces the same effect as pressing the front-panel reset button (see interface connector PWR1).

<b>Setting</b>	<b>Mode</b>	
Short 1-2	Timeout triggers non-maskable interrupt (NMI)	
Short 2-3	Timeout triggers system Reset (Default)	
Open	Disables watchdog timer	